



EH SERIES PROPORTIONAL ELECTRO-HYDRAULIC CONTROL VALVES

Pilot Relief / Relief / Reducing and Relieving /
Flow Control / Flow Control and Relief /
Directional and Flow Control

**PROPORTIONAL
CONTROLS**

Up to 24.5 MPa (3550 PSI), 400 L/min (106 U.S.GPM)

■ Pilot Relief Valves Page 3

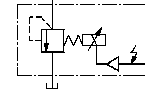

■ Relief Valves Page 4

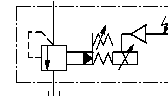

■ Reducing and Relieving Valves Page 5

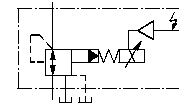

■ Flow Control Valves
Flow Control and Check Valves Page 6

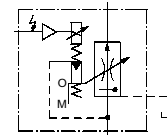

■ Flow Control and Relief Valves Page 7

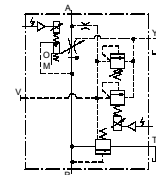

■ Directional and Flow Control Valves Page 8

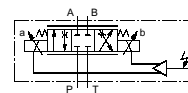

■ High Response Type
Directional and Flow Control Valves Page 9

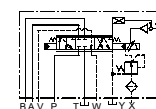

This catalogue introduce the outline of the EH series. Please refer to the catalogue titled "EH Series-Hybrid Components" (Cat. No. Pub. JC-1320) for the details such as performance characteristics and dimensions.

High-accuracy, simple, convenient EH Series realizes your dreams.

Why simple ?

Highly accurate hydraulic control can be obtained only by supplying 24 V DC power ③^{★3} and inputting a command signal voltage of 0 to 5 V ④^{★4}.

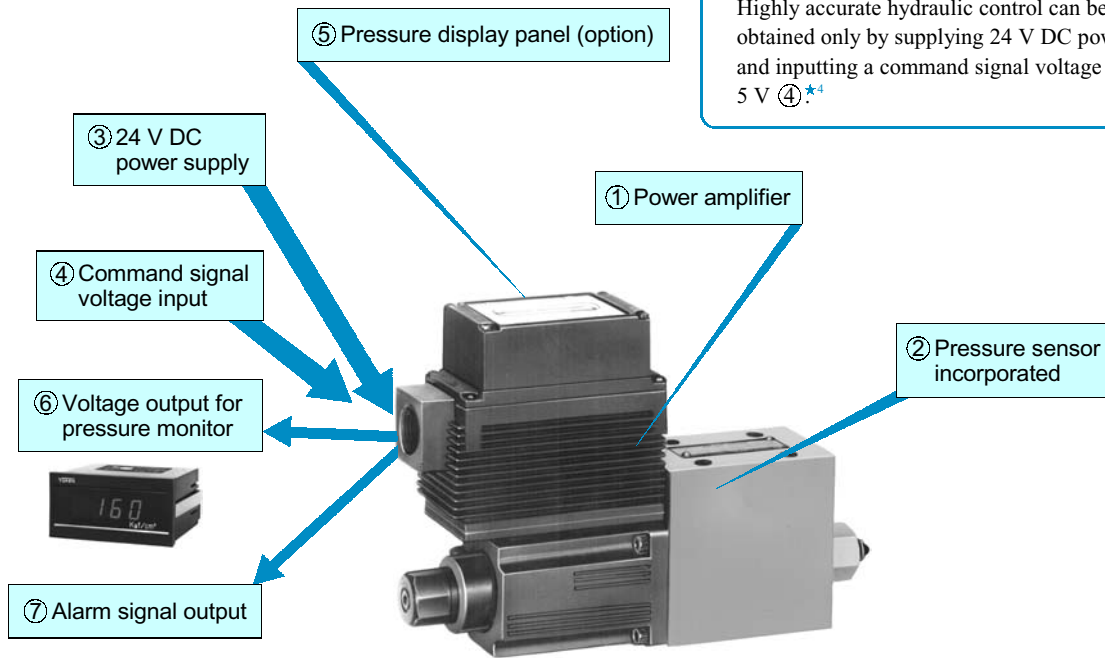

Details of Proportional Electro-hydraulic Relief Valve

Why high-accuracy ?

The power amplifier ① and pressure sensor ②^{★1} are integrated in the control valve. Furthermore, the closed-loop control^{★2} design greatly improves the linearity, hysteresis and stability in control pressure.

Why convenient ?

Control pressure^{★5} can be shown digitally on the optional pressure display panel ⑤.

Analog voltages can be output by using the incorporated sensor for monitoring pressure, etc. ⑥^{★5}.

Pressure can be displayed remotely with the Yuken's digital panel metre or any indicators obtainable in the market and also can be transmitted into a computer.

If any trouble arises in the system and the command signal does not match to the output, the alarm signal ⑦ is dispatched.

The trouble, if arises, can be easily detected by monitoring the dispatch of the alarm signal with sequence controller or computer.

- ★1. The sensor in directional control valves is to monitor the spool position. Valves without sensor are also available in both pressure control valves and directional control valves.
- ★2. Open-loop types are also available.
- ★3. EHDFG-04 and 06: ±24V DC power supply is needed.
- ★4. EHDFG-01, 03, 04 and 06: 0 to ±5V DC command signal is needed.
- ★5. EHDFG-04 and 06: The spool displacement is shown as a percentage.

The valve can be used as a pilot valve of the Proportional Electro-Hydraulic Control Valves.

The valve can also be used as a relief valve for the hydraulic system where a small flow rate and continuous pressure control are required.



Specifications

Model Numbers	EHDG-01*
Description	EHDG-01*
Max. Operating Pres.	24.5 MPa (3550 PSI)
Max. Flow	2 L/min (.53 U.S.GPM)
Min. Flow	0.3 L/min (.08 U.S.GPM)
Pressure Adjustment Range	Refer to Model Number Designation
Coil Resistance	10 Ω
Hysteresis	Less than 3% (1%)* ¹
Repeatability	Less than 1%* ²
Frequency Response	B : 10 (27) Hz* ¹ C : 10 (27) Hz* ¹ (-90 degree) H : 12 (27) Hz* ¹
Supply Electric Power	24 V DC (21 to 28 V DC Included Ripple)
Power Input (Max.)	28 W
Input Signal	B : 6.9 MPa (1000 PSI) / 5 V DC C : 15.7 MPa (2275 PSI) / 5 V DC H : 24.5 MPa (3550 PSI) / 5 V DC
Input Impedance	10 k Ω
Alarm Signal Output (Open Collector)	Voltage: Max. 30 V DC Current: Max. 40 mA
Pressure Signal Output	B : 5 V DC / 6.9 MPa (1000 PSI) C : 5 V DC / 15.7 MPa (2275 PSI) H : 5 V DC / 24.5 MPa (3550 PSI)
Ambient Temperature	0 - 50°C (32 - 122°F) (With Circulated Air)

★1. The value in () is for the closed-loop type.

★2. The repeatability of the valve is obtained by having it tested independently on the conditions similar to its original testing.

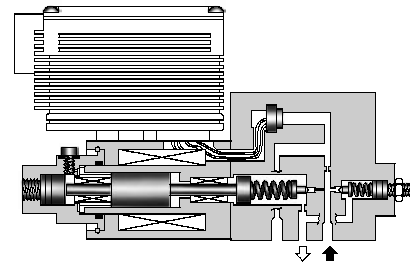

Graphic Symbols

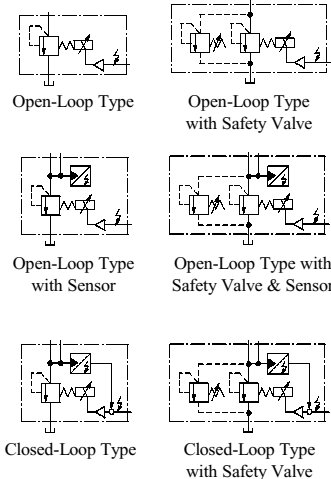

Model Number Designation

EHD	G	-01	V	-B	-S	D	-1	-PN	T15	M10	-50
Series Number	Type of Mounting	Valve Size	Applicable Control	Pres. Adj. Range MPa (PSI)	Control Type	DPM	Safety Valve	P-Line Orifice	T-Line Orifice	P-B Line Orifice	Design Number
EHD : Proportional Electro-Hydraulic Pilot Relief Valve	G : Sub-Plate Mounting	01	None : For general use V : Vent Control of Relief Valve (Omit if not required)	B : 0.5 - 6.9 (70 - 1000) C : 1 - 15.7 (145 - 2275) H : 1.2 - 24.5 (175 - 3550)	None : Open-Loop	None : Without DPM	None : Without Safety Valve 1 : With Safety Valve	PN : Without Orifice (Standard)	T15 T13 T11 ★ ²	M10 : Standard Orifice	50
					S : Open-Loop with Sensor L : Closed-Loop* ¹	None : Without DPM D : With DPM					

★1. For closed-loop models, specify applicable control code "V" even though the valve may not be used as vent control of relief valve.

★2. Standard of T-line Orifice.
Pres. Adj. Range B: T15, C: T13, H: T11.



These valves, consist of a small size but high performance EH series electro-hydraulic proportional pilot relief valve and a low noise type relief valve. The valves control the system pressure proportionally through a controlled input voltage.

Specifications

Model Numbers	EHBG-03	EHBG-06	EHBG-10
Description			
Max. Operating Pres.	24.5 MPa (3550 PSI)		
Max. Flow	100 L/min (26.4 U.S.GPM)	200 L/min (52.8 U.S.GPM)	400 L/min (106 U.S.GPM)
Min. Flow	3 L/min (.79 U.S.GPM)	3 L/min (.79 U.S.GPM)	3 L/min (.79 U.S.GPM)
Pressure Adjustment Range	Refer to Model Number Designation		
Coil Resistance	10 Ω		
Hysteresis	Less than 2% (1%) ^{★1}		
Repeatability	Less than 1% ^{★2}		
Frequency Response	C : 10 (22) Hz ^{★1} H : 10 (25) Hz ^{★1} (-90 degree)	C : 7 (15) Hz ^{★1} H : 9.5 (18) Hz ^{★1} (-90 degree)	C : 7 (10.5) Hz ^{★1} H : 6 (14) Hz ^{★1} (-90 degree)
Supply Electric Power	24 V DC (21 to 28 V DC Included Ripple)		
Power Input (Max.)	28 W		
Input Signal	C : 15.7 MPa (2275 PSI) / 5 V DC H : 24.5 MPa (3550 PSI) / 5 V DC (At Max. Flow)		
Input Impedance	10 kΩ		
Alarm Signal Output (Open Collector)	Voltage: Max. 30 V DC Current: Max. 40 mA		
Pressure Signal Output	C : 5 V DC / 15.7 MPa (2275 PSI) H : 5 V DC / 24.5 MPa (3550 PSI)		
Ambient Temperature	0 - 50°C (32 - 122°F) (With Circulated Air)		

★1. The value in () is for the closed-loop type.

★2. The repeatability of the valve is obtained by having it tested independently on the conditions similar to its original testing.

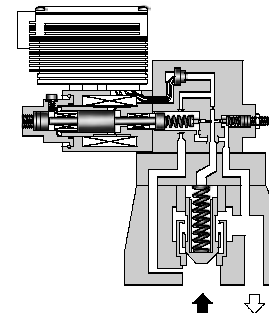

Graphic Symbols

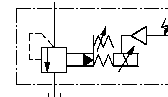

Open-Loop Type

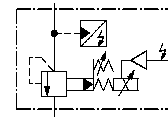

Open-Loop Type with Sensor

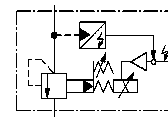

Closed-Loop Type

Model Number Designation

EHB	G	-03	-C	-S	D	-50
Series Number	Type of Mounting	Valve Size	Pres. Adj. Range MPa (PSI)	Control Type	DPM	Design Number
EHB : Proportional Electro-Hydraulic Relief Valve	G : Sub-Plate Mounting	03	C : 0.6 [0.8] [★] - 15.7 (85 [115] [★] - 2275) H : 0.6 [0.8] [★] - 24.5 (85 [115] [★] - 3550)	None : Open-Loop	None : Without DPM	50
		06	C : 0.9 [1.0] [★] - 15.7 (130 [145] [★] - 2275) H : 0.9 [1.0] [★] - 24.5 (130 [145] [★] - 3550)	S : Open-Loop with Sensor	None : Without DPM	50
		10	C : 1.1 [1.4] [★] - 15.7 (160 [205] [★] - 2275) H : 1.1 [1.4] [★] - 24.5 (160 [205] [★] - 3550)	L : Closed-Loop	D : With DPM	50

★ Each value of minimum adjustment pressure is of at 50% flow rate of the Max. Flow shown on the Specifications. The value in [] is for the closed-loop type.

These valves consist of a small size but high performance electro-hydraulic proportional pilot relief valve and reducing valve with relief function. The valves control the system pressure proportionally through a controlled input voltage. Moreover, a good response speed in reducing the pressure even at a large load capacity can be obtained with the relief function of the valves.

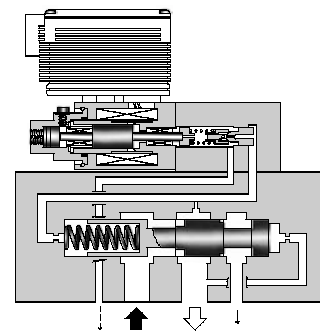

■ Specifications

Model Numbers	EHRBG-06	EHRBG-10
Description		
Max. Operating Pres.	24.5 MPa (3550 PSI)	
Max. Flow	100 L/min (26.4 U.S.GPM)	250 L/min (66 U.S.GPM)
Max. Relieving Flow	35 L/min* ¹ (9.24 U.S.GPM)	15 L/min* ¹ (3.96 U.S.GPM)
Pressure Adjustment Range	Refer to Model Number Designation	
Coil Resistance	10 Ω	
Hysteresis	Less than 3%	
Repeatability	Less than 1%* ²	
Frequency Response	B : 4 Hz C : 3 Hz (-90 degree) H : 3 Hz	
Supply Electric Power	24 V DC (21 to 28 V DC Included Ripple)	
Power Input (Max.)	28 W	
Input Signal	B : 6.9 MPa (1000 PSI) / 5 V DC C : 13.7 MPa (2000 PSI) / 5 V DC H : 20.6 MPa (3000 PSI) / 5 V DC (at Flow Rate Zero)	
Input Impedance	10 kΩ	
Pressure Signal Output	B : 5 V DC / 6.9 MPa (1000 PSI) C : 5 V DC / 13.7 MPa (2000 PSI) H : 5 V DC / 20.6 MPa (3000 PSI)	
Ambient Temperature	0 - 50°C (32 - 122°F) (With Circulated Air)	

★1. The figures shown are those obtained where the differential pressure between the secondary pressure port and tank port is 14 MPa (2030 PSI).

★2. The repeatability of the valve is obtained by having it tested independently on the conditions similar to its original testing.

Graphic Symbols

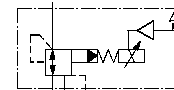

Open-Loop Type

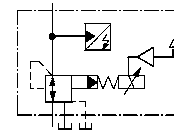

Open-Loop Type with Sensor

■ Model Number Designation

EHRB	G	-06	-C	-S	D	-50
Series Number	Type of Mounting	Valve Size	Pres. Adj. Range MPa (PSI)	Control Type	DPM	Design Number
EHRB: Proportional Electro-Hydraulic Reducing & Relieving Valve	G: Sub-Plate Mounting	06	B : 0.8 - 6.9 (115 - 1000) C : 1.2 - 13.7 (175 - 2000) H : 1.5 - 20.6 (220 - 3000)	None: Open-Loop	None: Without DPM	50
		10	B : 0.9 - 6.9 (130 - 1000) C : 1.2 - 13.7 (175 - 2000) H : 1.5 - 20.6 (220 - 3000)	S: Open-Loop with Sensor	D: With DPM	50



The system flow rate can be controlled remotely as desired by regulating input voltage. Further, since pressure and temperature compensation functions are provided, the preselected flow rate is not affected by pressure (load) or temperature (fluid viscosity).



Specifications

Model Numbers	EHF*G-03- ⁶⁰ / ₁₂₅	EHF*G-06-250	
Description			
Max. Operating Pres. MPa (PSI)	20.6 (3000)	24.5 (3550)	
Max. Metred Flow L/min (U.S.GPM)	60 : 60 (15.8) 125 : 125 (33)	250 (66)	
Min. Metred Flow L/min (U.S.GPM)	1 (.26)	2.5 (.66)	
Min. Differential Pressure* ¹ MPa (PSI)	1.0 (145)	1.0 (145)	
Free Flow L/min (U.S.GPM) (Only with Check Valve)	130 (34.3)	280 (73.9)	
Pilot Flow L/min (U.S.GPM)	at Normal	0.5 (.13)	1 (.26)
	at Transition	2.6 (.69)	4 (1.06)
Min. Pilot Pressure MPa (PSI)	1.0 (145)	1.5 (215)	
Frequency Response	12 Hz (-90 degree)		
Hysteresis	Less than 3%		
Repeatability	Less than 1%* ²		
Coil Resistance	10 Ω		
Supply Electric Power	24 V DC (21 to 28 V DC Included Ripple)		
Power Input (Max.)	28 W		
Input signal	Max. Metred Flow / 5V DC		
Input Impedance	10 kΩ		
Ambient Temperature	0 - 50°C (32 - 122°F) (With Circulated Air)		

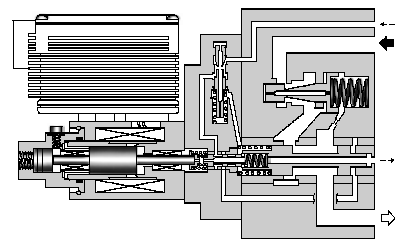

Graphic Symbols

● EHFG

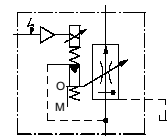

Internal Pilot

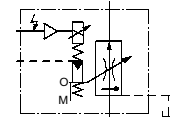

External Pilot

● EHFCG

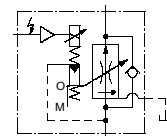

Internal Pilot

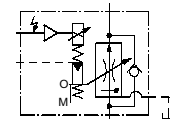

External Pilot

- ★1. Minimum differential pressure means fine pressure compensation at inlet and outlet port.
- ★2. The repeatability of the valve is obtained by having it tested independently on the conditions similar to its original testing.

Model Number Designation

EHF	G	-03	-60	-E	-50
Series Number	Type of Mounting	Valve Size	Max. Metred Flow L/min (U.S.GPM)	Pilot Connection	Design Number
EHF : Proportional Electro-Hydraulic Flow Control Valve EHFC : Proportional Electro-Hydraulic Flow Control and Check Valve	G : Sub-Plate Mounting	03	60 : 60 (15.8) 125 : 125 (33)	None : Internal Pilot E : External Pilot	50
		06	250 : 250 (66)		50

These are proportional electro-hydraulic flow control valves having functions for controlling the direct electric current of metre-in type and for pressure control. They are energy-saving valves for supplying the minimal pressure and flow required to operate actuators.



Specifications

Model Numbers		EHFBG-03- ⁶⁰ / ₁₂₅	EHFBG-06-250	EHFBG-10-500	
Description					
Max. Operating Pressure MPa (PSI)		24.5 (3550)	24.5 (3550)	24.5 (3550)	
Max. Flow L/min (U.S.GPM)		60 : 60 (15.8) 125 : 125 (33)	250 (66)	500 (132)	
Metred Flow Capacity L/min (U.S.GPM)		60 : 1-60(.26-15.8) 125 : 1-125(.26-33)	2.5-250 (.66-66)	5-500 (13.2-132)	
Min. Pilot Pressure MPa (PSI)		1.5 (215)	1.5 (215)	1.5 (215)	
Pilot Flow L/min (U.S.GPM)		at Normal	1 (.26)	1 (.26)	
		at Transition	3 (.79)	4 (1.06)	
Differential Pressure MPa (PSI)		0.6 (85)	0.7 (100)	0.9 (130)	
Flow Controls	Hysteresis	Less than 3%			
	Repeatability	Less than 1%*			
	Input Signal	Max. Flow / 5 V DC			
	Coil Resistance	10 Ω			
	Supply Electric Power	24 V DC (21 to 28 V DC Included Ripple)			
	Input Impedance	10 kΩ			
	Power Input (Max.)	28 W			
Pressure Controls	Pres. Adj. Range MPa (PSI)	Adj. Range: C	1.2-15.7 (175-2275)	1.4-15.7 (200-2275)	1.5-15.7 (215-2275)
		Adj. Range: H	1.4-24.5 (200-3550)	1.4-24.5 (200-3550)	1.5-24.5 (215-3550)
	Hysteresis	Less than 2%			
	Repeatability	Less than 1%*			
	Coil Resistance	10 Ω			
	Input Signal	Max. Operating Pres. / 5 V DC			
	Supply Electric Power	24 V DC (21 to 28 V DC Included Ripple)			
Input Impedance	10 kΩ				
Power Input (Max.)	28 W				
Output Signal		C : 5 V DC / 15.7 MPa (2275 PSI) H : 5 V DC / 24.5 MPa (3550 PSI)			
Ambient Temperature		0 - 50°C (32 - 122°F) (With Circulated Air)			

*The repeatability of the valves is obtained by having it tested independently on the conditions similar to its original testing.

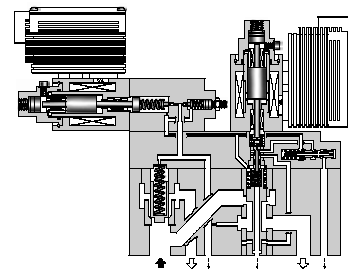

Graphic Symbols

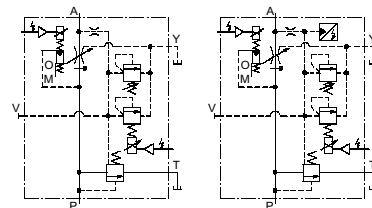

Models with Proportional Pilot Relief Valves

Models with Proportional Pilot Relief Valves and Sensor

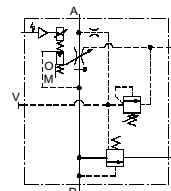

Models without Proportional Pilot Relief Valves



External Pilot Pres. Connection

Model Number Designation

EHFB	G	-03	-60	-C	-E	-S	D	-50
Series Number	Type of Mounting	Valve Size	Max. Metred Flow L/min (U.S.GPM)	Pilot Relief Valve Pres. Adj. Range	Pilot Connection of Flow Control	Pressure Controls	DPM of Pres.*	Design Number
EHFB : Proportional Electro-Hydraulic Flow Control and Relief Valve	G : Sub-Plate Mounting	03	60 : 60 (15.8) 125 : 125 (33)	None : Without Proportional Pilot Relief Valve	None : Internal Pilot	None : Open-Loop	None : Without DPM	50
		06	250 : 250 (66)					50
		10	250 : 500 (132)	C, H : See Specifications	E : External Pilot	S : Open-Loop with Sensor	D : With DPM	50

*DPM is available only for the models with Pressure Controls "S".



These valves incorporate two control functions - flow and direction - which simplify the hydraulic circuit composition and therefore the cost of the system is reduced.

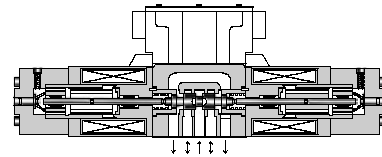

Specifications

Model Numbers		EHDFG-01	EHDFG-03
Description			
Max. Operating Pressure	MPa (PSI)	24.5 (3550)	24.5 (3550)
Max. Tank Line Back Pres.	MPa (PSI)	7 (1020)	7 (1020)
Rated Flow	L/min (U.S.GPM)	30 (7.92)	60 (15.9)
[Valve ΔP 6.9 MPa (1000 PSI)]			
Hysteresis		Less than 5%	
Repeatability		Less than 1% *	
Frequency Response		20 (-90 deg.) Hz	17 (-90 deg.) Hz
Coil Resistance		10.5 Ω	8.0 Ω
Supply Electric Power		24 V DC (21 to 28 V DC Included Ripple)	
Input Voltage	By Controlling Variable Resistance (Using of Power from Amp.)	1 - 2 kΩ Volume Range	
	By Controlling Voltage (Using of Power outside Amp.)	0 ~ -5 V for SOL a	0 ~ +5 V for SOL b
Input Impedance		10 kΩ	10 kΩ
Power Input (Max.)		40 W	45 W
Ambient Temperature		0 - 50°C (32 - 122°F) (With Circulated Air)	

*The repeatability of the valves is obtained by having it tested independently on the conditions similar to its original testing.

Graphic Symbols

● Metre-in • Metre-out Control

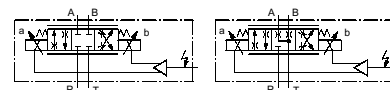

3C2

3C40

● Metre-out Control

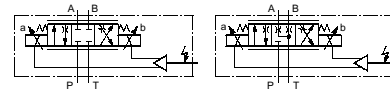

3C2

3C40

● Metre-in Control

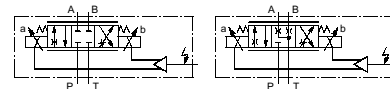

3C2

3C40

Model Number Designation

EHDFG	-01	-30	-3C2	-E	-30
Series Number	Valve Size	Rated Flow L/min (U.S.GPM)	Spool Type *	Direction of Flow	Design Number
EHDFG: Proportional Electro-Hydraulic Directional and Flow Control Valve (Sub-Plate Mounting)	01	30 : 30 (7.92)	3C2	XY : Metre-in • Metre-out X : Metre-in Y : Metre-out	30
	03	60 : 60 (15.9)	3C40		30

*Spool type shown in the column is for the centre position.

EH SERIES High Response Type Directional and Flow Control Valves EHDFG-04/06 (1/2, 3/4) Sub-plate Mounting

These valves pursue the ultimate performance of proportional electro-hydraulic directional & flow control valves and make themselves to have high response features.

The closed-loop is composed in the valve inside by combination of a differential transformer (LVDT) and a power amplifier. Thus, high accuracy and reliability are provided.

In addition to control in the open-loop, these can be used for the closed-loop system as simplified servo valves.

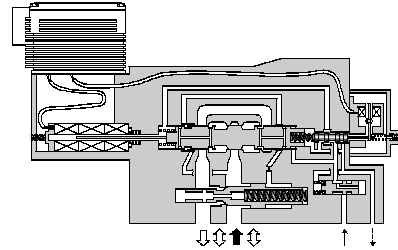

Specifications

Model Numbers		EHDFG-04	EHDFG-06
Description			
Max. Operating Pres.	MPa (PSI)	15.7 (2275)	15.7 (2275)
Rated Flow	L/min (U.S.GPM)	130 (34.3)	280 (73.9)
Valve Pres. Difference: 1.5 MPa (215 PSI)			
Min. Required Pilot Pres.	MPa (PSI)	1.5 (215)	1.5 (215)
Min. Required Pilot Flow	at Normal	2 (.53)	2 (.53)
	at Transition	6 (1.59)	10 (2.64)
Max. Drain Line Back Pres.	MPa (PSI)	0.1 (15)	0.1 (15)
Hysteresis	Less than 1%		
Repeatability	Less than 1%*		
Frequency Response		55 Hz (-90 deg.)	45 Hz (-90 deg.)
Coil Resistance		30 Ω	30 Ω
Supply Electric Power	±24 V DC (±21 to ±28 V DC Included Ripple)		
Input Signal	Rated Flow / ±5 V DC		
Input Impedance		10 kΩ	10 kΩ
Power Input (Max.)		20 W	20 W
Alarm Signal Output (Open Collector)	Voltage: Max. 30 V DC Current: Max. 30 mA		
LVDT Output (Sensor Monitor)	±5 V DC / Rated Travel of Spool		
Ambient Temperature	0 - 50°C (32 - 122°F) (With Circulated Air)		

★ The repeatability of the valves is obtained by having it tested independently on the conditions similar to its original testing.

Graphic Symbols

- Models without Pressure Compensator Valve

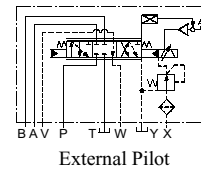
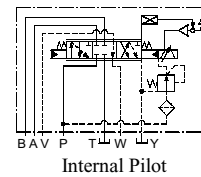

- Models with Pressure Compensator Valve

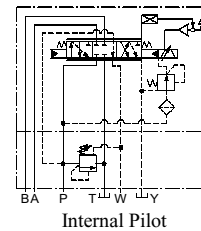

Model Number Designation

EHDFG	-04	-130	-2	-E	-D	-CB	-10
Series Number	Valve Size	Rated Flow L/min (U.S.GPM)	Spool Type*	Pilot Connection	DPM	Relief Type Pres. Compensator	Design Number
EHDFG: Proportional Electro-Hydraulic Directional and Flow Control Valve (Sub-Plate Mounting)	04	130: 130 (34.3)	2	None: Internal Pilot	None: Without DPM	None: Not Provided	10
	06	280: 280 (73.9)	40	E: External Pilot	D: With DPM	CB: Provided	10

★ Spool type shown in the column is for the centre position.

